

# 450

EXECUTIVE



**IFT** è sinonimo internazionale di Executive Furniture e Meeting Tables, ossia di arredi direzionali e tavoli riunione belli, polifunzionali, confortevoli con opzioni tra prestigiose scelte in fatto di materiali e finiture tecnologicamente avanzate ad alta definizione estetica. Mobili perfetti per essere rappresentativi e operativi in ogni attività della vita aziendale, in presenza e in remoto.

**IFT** ha ben chiaro quanto siano importanti, all'interno delle Imprese, gli spazi che è chiamata ad arredare.

Spazi e stanze dove ci si incontra per eventi periodici o speciali, scambi, condivisioni, progetti, vertici, presentazioni e accoglienza.

**IFT** significa specifica competenza nel favorire incontri tra persone che lavorano in modalità di condivisione.

E, seguendo le regole della prossemica, dello studio dell'uso che gli individui fanno dello spazio sociale e personale, i suoi tavoli aperti garantiscono comunque a ciascuno la propria autonomia.

**Quarantacinque e Novanta.** 2 angoli. 2 orientamenti di linee nello spazio per risposte articolate alle esigenze più complesse.

**IFT** is internationally known for its attractive, multipurpose, comfortable Executive Furniture and Meeting Tables, offering options such as choice materials and visually impressive high-tech finishes. Perfect furniture for efficiency and prestige in all aspects of the business's life, face-to-face or remotely.

**IFT** is well aware of the vital importance of the interiors it furnishes for the companies concerned. Locations and rooms where people meet for regular or special events, discussions, sharing, plans, summits, presentations and entertaining.

**IFT** is uniquely skilled in supporting meetings where people can, collaborate and share effectively.

And, conforming to the rules of proxemics, the study of the way people utilise social and personal spaces, its open tables guarantee the independence of each user.

**Quarantacinque e Novanta. Forty-five and Ninety.** 2 angles. 2 directions of lines in space, for structured solutions to the most complex needs.



Roberto e Alfredo Garbugli, designers

# 4590

EXECUTIVE







**tavoli riunione / meeting tables**



02 / .....pag 6



02.2 / .....pag 12

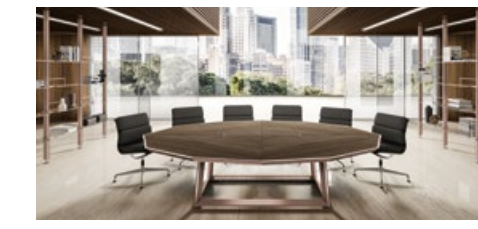

04 / .....pag 14



07 / ..... pag 18



05 / .....pag 24



10 / .....pag 30



08 / ..... pag 36



11 / .....pag 43



12 / .....pag 46



13 / .....pag 47

**tavoli direzionali / executive tables**



14 / .....pag 50



16 / .....pag 52



17 / .....pag 54



15 / .....pag 56



18 / .....pag 57

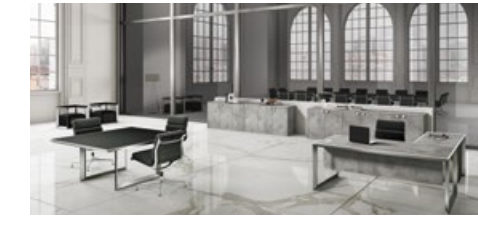

19 / .....pag 58

**finiture / finishes.....62**

**disegni tecnici / technical drawings..... 68**



# meeting tables

**IFT** ha a cuore il vostro staff e i vostri ospiti e mette a disposizione tutto il meglio in fatto di design, materiali, finiture e tipologie coniugando estetica, funzionalità e tecnologia applicata.

Consapevole che non esistano materiali più belli di altri ma che la scelta dipenda dai gusti personali, **IFT** ha ampliato notevolmente la propria produzione storica con tavoli tutti da preferire.

**IFT** cares about your staff and your guests, and provides the very best in terms of design, materials, finishes and types, combining style, function and applied technology.

Aware that the beauty of a material lies in the eye of the beholder, **IFT** has considerably expanded its historic range, with tables to suit all tastes.





02

**Hello.**

Since everyone is here,  
let's get started.

Visto che siamo tutti qui, iniziamo.



6/7







# 02.1



**The first point on the agenda**  
is how always to provide tables  
that deliver on concepts like space,  
comfort, visibility and ergonomics.

Il primo punto in agenda è come prevedere sempre tavoli  
che rispondano a concetti come spazio, comfort, visibilità ed ergonomia.

**STRUTTURA** / FRAME: Iridium. **PIANO** / TOP: Okobo. **MISURA** / SIZE: 560 X 160 cm.





12 / 13

12 / 13

02.2

STRUTTURA / FRAME: Iridium. PIANO / TOP: Nero Marquinia / Black Marquinia. MISURA / SIZE: 400 X 200 cm.



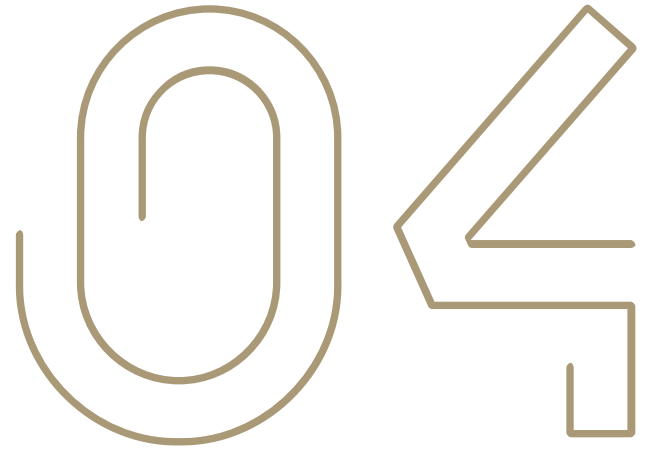

**Today**, we are here to discuss how to enter and leave the comfort zone with ease.

Oggi siamo qui per discutere di come entrare e uscire facilmente dalla comfort zone.

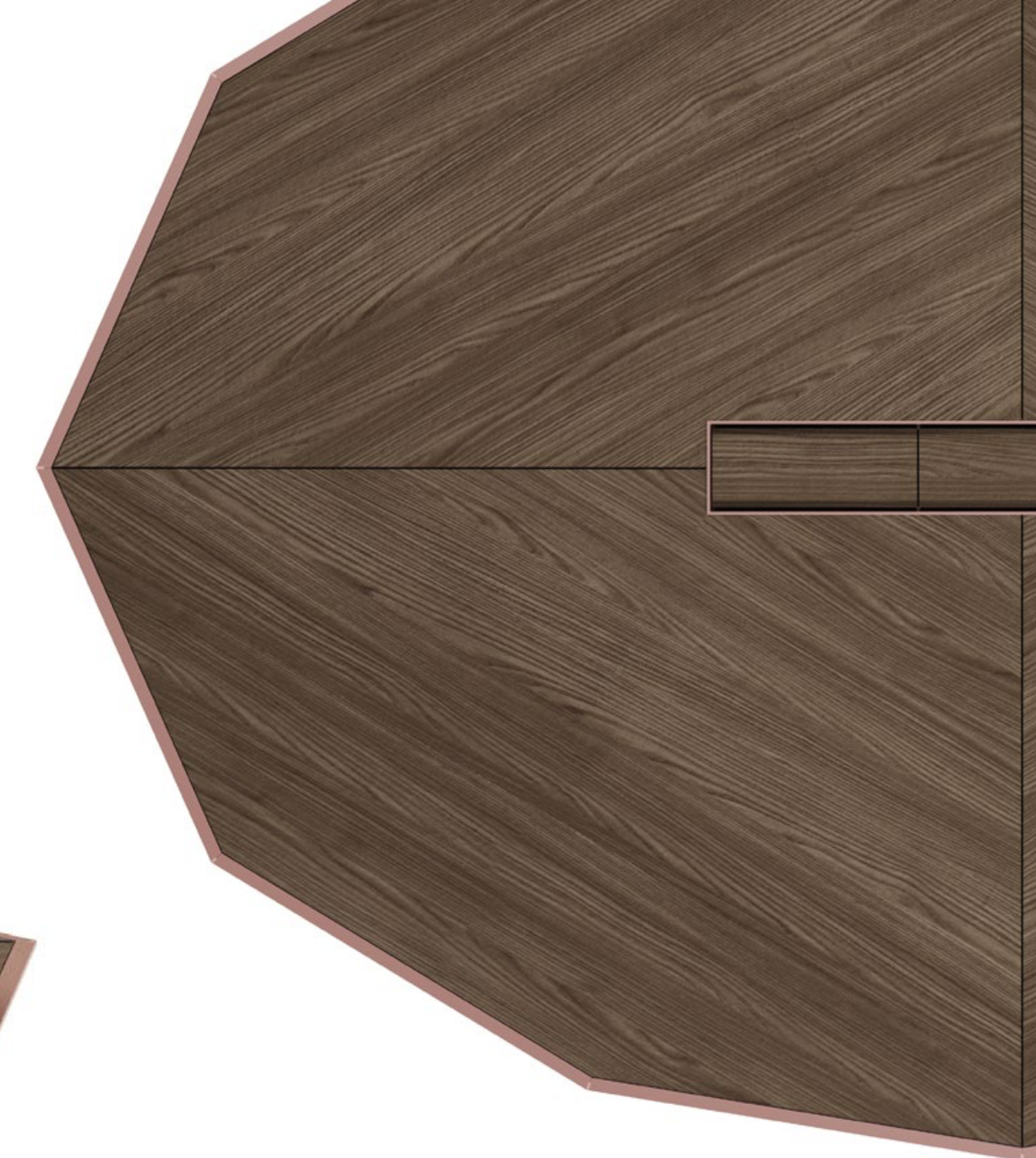





16/17

16/17



07



**Pleasure in the job**  
puts perfection in the work.  
When the table is this.

Il piacere del lavoro aggiunge perfezione al compito  
che svolgiamo. Quando il tavolo è questo.

STRUTTURA / FRAME: Zinc. PIANO / TOP: Ares. MISURA / SIZE: 215 X 215 cm.







# Librerie / Bookcases

La libreria sfrutta lo stesso profilo utilizzato per la struttura dei tavoli, con possibilità di fissaggio a parete o a soffitto. Lo speciale reggipiano permette la rotazione dei moduli.

The bookcase shares the same profile as the table frame and can be fixed to a wall or ceiling. The special shelf support allows modules to be rotated.

23



22



21



MISURA / SIZE: L. 90 x P. 35 x H 240/300 cm.

28



29



MISURA / SIZE: L. 90 x P. 37 x H 240 cm.





05



STRUTTURA / FRAME: Iridium. PIANO / TOP: Fronda S165. MISURA / SIZE: 180 X 180 cm.



**Can I just say  
a word?**

I think it's perfectly  
ergonomic.

Posso dire solo una parola?  
Lo trovo perfettamente ergonomico.







## Poltroncine / Easy chairs

24



25



26



**STRUTTURA** / STRUCTURE: Iridium. **SEDUTA** / SEAT: Cuoio Nero/Black Leather. **MISURA** / SIZE: L. 65 x P. 66 x H. 68,2 cm.

## Tavolo caffè / Coffee table

27



**STRUTTURA** / FRAME: Iridium. **TOP** / TOP: Fronda S165. **MISURA** / SIZE: L. 120 x P. 60 x H. 45 cm.





10

**Let's open the discussion.**  
Great! With eighteen people  
comfortably seated.

Apriamo la discussione. Grande!  
In diciotto seduti confortevolmente come a casa.

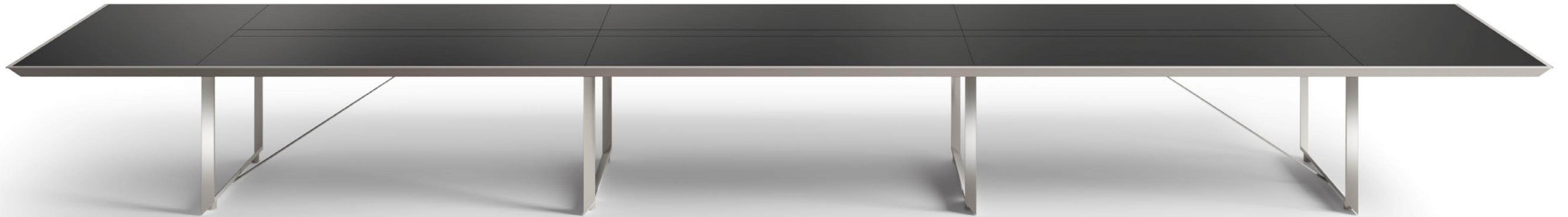

**STRUTTURA** / FRAME: Alluminio Brill. **PIANO** / TOP: Piombo HM07 Nero / Lead Grey HM07 Black. **MISURA** / SIZE: 560 x 200 cm.











02

**Do you want to know what I think?** This is an excellent example of high quality in a compact size.

Posso dire una cosa? Questo è un eccellente esempio di alta qualità in dimensioni ridotte.

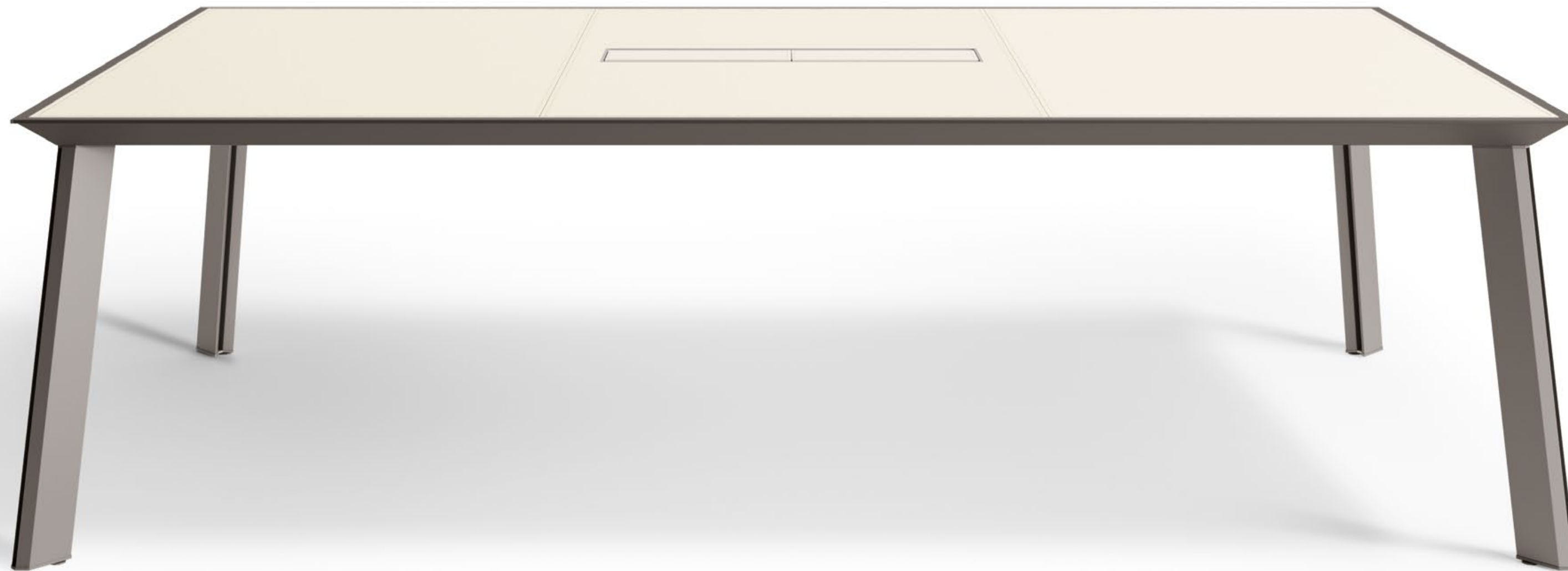

**STRUTTURA** / FRAME: Zinc. **PIANO** / TOP: Cuoio Bianco/White Leather.  
**MISURA** / SIZE: 240 X 120 cm.



02.2





# 02.3

**STRUTTURA / FRAME:** Zinc.  
**PIANO / TOP:** Piombo HM05 Grigio / Lead Grey HM05 Grey.  
**MISURA / SIZE:** 320 X 120 cm.





**Our tables will  
travel the world.**

Making spaces  
more beautiful.

I nostri tavoli andranno  
in giro per il mondo.  
In spazi sempre più belli.

**MOBILI / CABINETS**  
**STRUTTURA / STRUCTURE:**  
Piombo HM00 Bianco / Lead Grey HM00 White.  
**PIANO / TOP:** Bianco Venato / Veined White.



**TAVOLO RIUNIONE - MEETING TABLE**  
**STRUTTURA / FRAME:** Rosegold.  
**PIANO / TOP:** Bianco Venato / Veined White.  
**MISURA / SIZE:** 400 x 200 cm.









**STRUTTURA** / FRAME: Rose Gold. **PIANO** / TOP: Emperador. **MISURA** / SIZE: 400 X 200 cm.

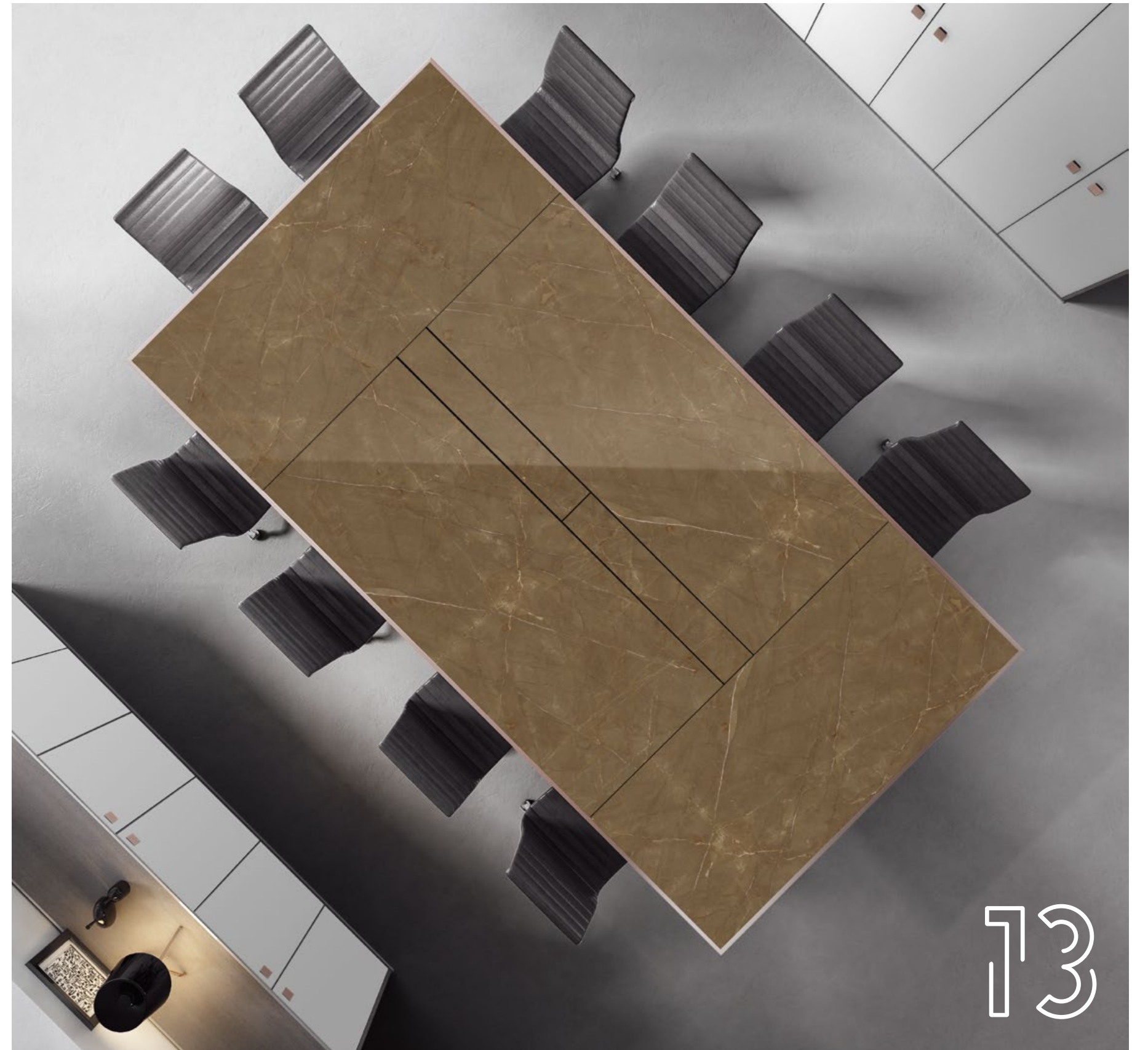

**STRUTTURA** / FRAME: Rose Gold. **PIANO** / TOP: Gaudi Stone Extra. **MISURA** / SIZE: 400 X 200 cm.



# executive furniture

Rappresentativi e operativi, i mobili per uffici direzionali **IFT** uniscono tecnica ed arte in soluzioni fatte di volumi e dettagli meticolosamente studiati, in materiali e finiture accuratamente scelti.

**IFT** significa sistemi d'arredo per ambienti destinati al lavoro di concetto e operativo. Postazioni di lavoro, studio, lettura, flessibili e funzionali. Ideali per ambienti che evolvono, crescono, cambiano

Impressive yet functional, **IFT** executive furniture combines technology and art in solutions with meticulously designed forms and details, in carefully chosen materials and finishes.

**IFT** stands for furnishing systems for managerial and operative working areas. Flexible, functional work, study and reading stations. Ideal for interiors that evolve, grow and change





Today we're  
**discussing** how to  
bring pleasure and  
comfort to work.

Oggi penseremo a come  
lavorare in modo piacevole  
e confortevole.

50 / 51

**SCRIVANIA / DESK**  
**STRUTTURA / FRAME:** Nero Opaco / Matt Black.  
**PIANO / TOP:** Piombo HM07 Nero / Lead grey HM07 Black.  
**MOBILE / CABINET**  
**STRUTTURA / STRUCTURE:** Piombo HM07 Nero / Lead grey HM07 Black.  
**ANTA / DOOR:** Vetro Antracite Opaco / Anthracite Matt Glass.





**These interiors  
are so welcoming.**

We know what it  
takes for success  
on every market.

Gli interni sono così confortevoli.  
Sappiamo cosa serve per avere  
successo in ogni mercato.

**SCRIVANIA / DESK**  
**STRUTTURA / FRAME:** Iridium.  
**PIANO / TOP:** Cuoio Testa di Moro / Dark Brown Leather.  
**MOBILE / CABINET**  
**STRUTTURA / STRUCTURE:** Fronda S156.  
**TAVOLO RIUNIONE / MEETING TABLE**  
**STRUTTURA / FRAME:** Iridium.  
**PIANO / TOP:** Cuoio Testa di Moro / Dark Brown Leather.



17

**SCRIVANIA / DESK**  
**STRUTTURA / FRAME:** Zinc. **PIANO / TOP:** Fronda S165.  
**MOBILE / CABINET**  
**STRUTTURA / STRUCTURE:** Fronda S156.  
**ANTA / DOOR:** Vetro Bianco / White Glass.

54 / 55

54 / 55

Please reply to this email to confirm  
you can attend tomorrow's conference call.  
We'll be at the meeting table.  
Thank you everyone.

Prego, rispondere a questa mail per confermare disponibilità  
alla conference call di domani. Noi saremo al tavolo riunioni. Grazie a tutti.





15

**SCRIVANIA / DESK**  
**STRUTTURA / FRAME:** Bianco / White. **PIANO / TOP:** Okobo.  
**MISURA / SIZE:** 220X90 cm.

**CASSETTIERA / DRAWER UNIT**  
**STRUTTURA / STRUCTURE:** Okobo.



18

**SCRIVANIA / DESK**  
**STRUTTURA / FRAME:** Brill. **PIANO / TOP:** Cuoio fango / Mud finish leather.  
**MISURA / SIZE:** 240 X 120 cm.

**MOBILE E CASSETTIERA / CABINET AND DRAWER UNIT**  
**STRUTTURA / STRUCTURE:** Okobo.



**TAVOLI RIUNIONE - MEETING TABLES**

**STRUTTURA / FRAME:** Brill.

**PIANO / TOP:** Cuoio Nero / Black Leather.

**SCRIVANIA / DESK**

**STRUTTURA / FRAME:** Brill. **PIANO / TOP:** Ares FB11.

**MOBILI / CABINETS**

**STRUTTURA / STRUCTURE:** Ares FB11.





1



2



3



4

- 1 PARTICOLARE NUOVO ANGOLO STONDATO PER SCRIVANIE E TAVOLI RIUNIONE.  
DETAIL OF NEW ROUNDED CORNER FOR DESKS AND MEETING TABLES.
- 2 CARTER SALITA CAVI E VASCHETTA SOTTOPIANO. FLOOR-TO-TOP WIRING RACEWAY AND UNDER-TOP WIRING COMPARTMENT.
- 3 DETTAGLIO PROFILO IN ALLUMINIO PER TOP CONTENITORE. DETAIL OF ALUMINIUM PROFILE FOR STORAGE UNIT TOPS.
- 4 PANNELLO SUPERIORE APRIBILE PER ACCESSO VASCHETTA CONTENITORE CAVI. WIRING COMPARTMENT TOP PANEL, OPENABLE FOR ACCESS.
- 5 SOSTEGNO CENTRALE CON CARTER SALITA CAVI PER TAVOLO 08.3 (320 X 120 cm). CENTRAL LEG WITH FLOOR-TO-TOP WIRING RACEWAY FOR 08.3 TABLE (320 X 120 cm).
- 6 TOP ACCESS.
- 7 CARTER SALITA CAVI PER TAVOLI RIUNIONE. FLOOR-TO-TOP WIRING RACEWAY FOR MEETING TABLES.



5



6



7



# finiture

finishes

# finiture

finishes



HPL/HPL



**Piombo HM07 Nero**  
Lead Grey HM07 Black

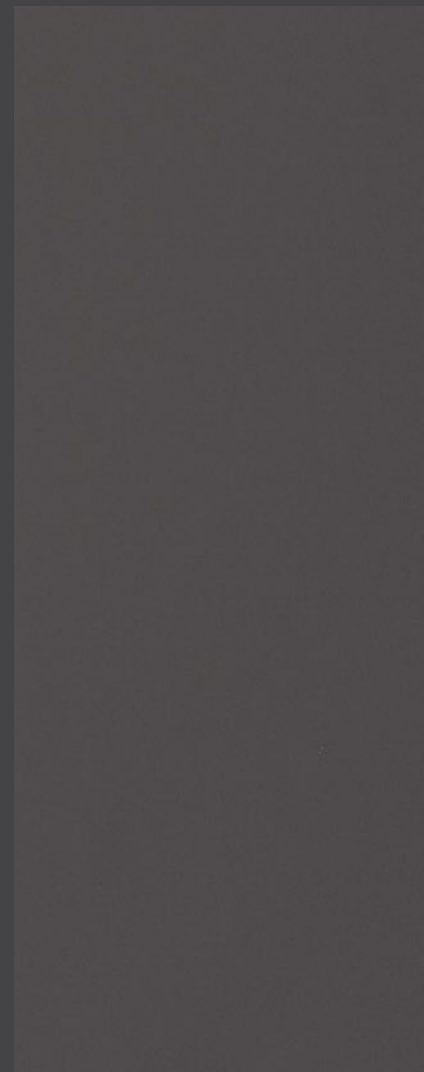

**Piombo HM05 Grigio**  
Lead Grey HM05 Grey



**Piombo HM00 Bianco**  
Lead Grey HM00 White



**Ares FB11 Beton**

HPL/HPL



**Fronda S165**



**Fronda S156**



**Okobo S160**



# finiture

finishes



# finiture per piani e ante contenitori

storage unit top and door finishes

## CUOIO / LEATHER



**Cuio Testa di Moro**  
Dark Brown Leather



**Cuio Nero**  
Black Leather



**Cuio Bianco**  
White Leather



**Cuio Fango**  
Mud finish leather

## VETRO RETROLACCATO OPACO / MATT BACK-LACQUERED GLASS



**Vetro Antracite**  
Anthracite Glass



**Vetro Bianco**  
White Glass



# finiture per piani e top contenitori

storage unit top finishes

CERAMICA TECNICA / CERAMICA TECNICA

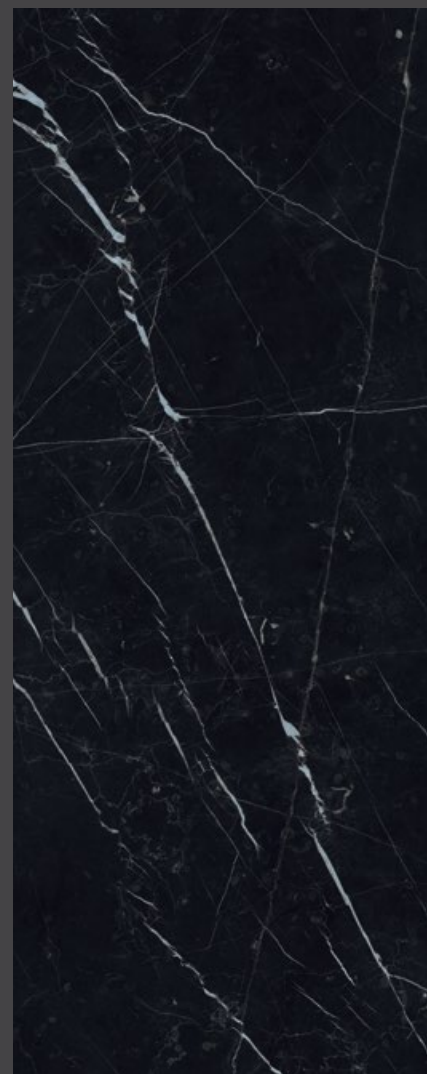

Nero Marquinia  
Black Marquinia



Bianco Venato  
Veined White

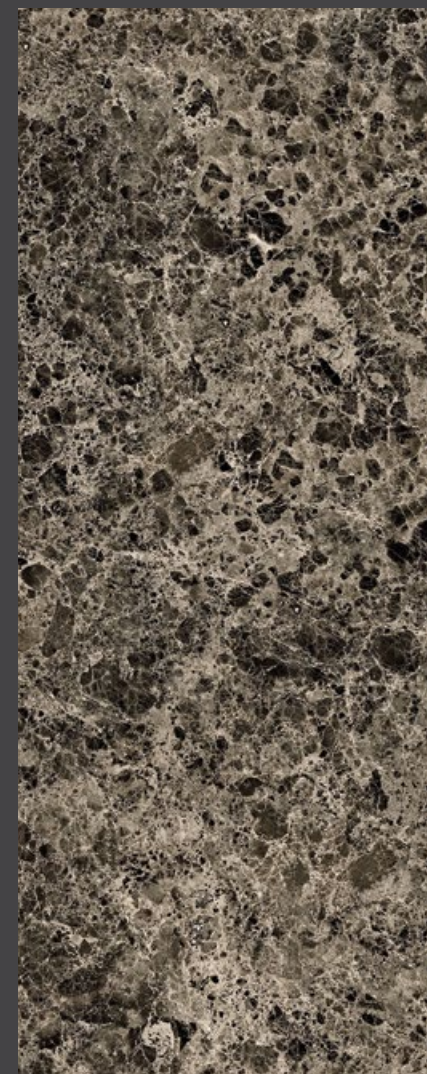

Emperador

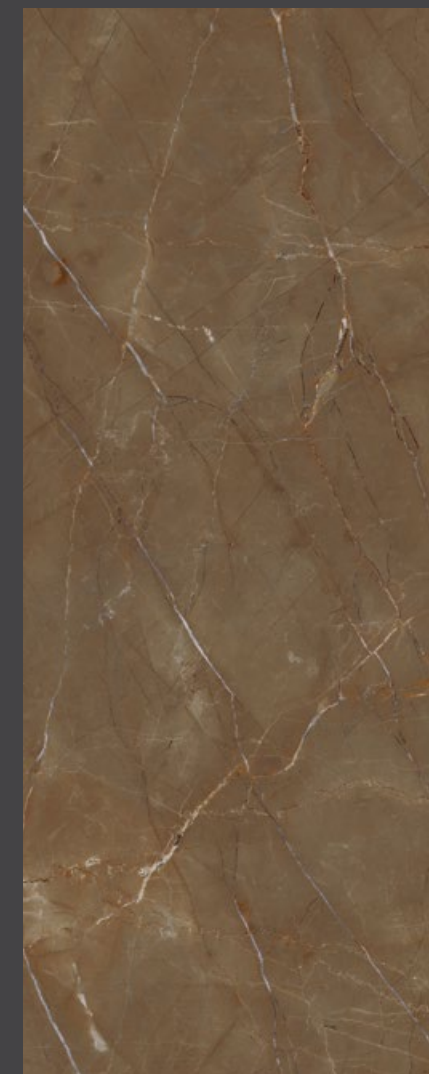

Gaudi Stone Extra

# finiture per struttura

frame finishes

ALLUMINIO / ALUMINUM

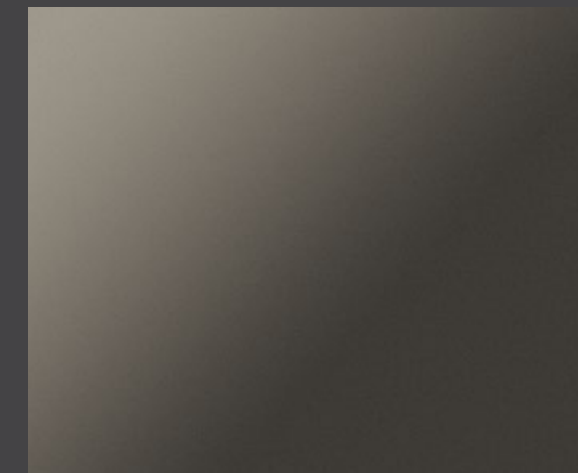

Zinc

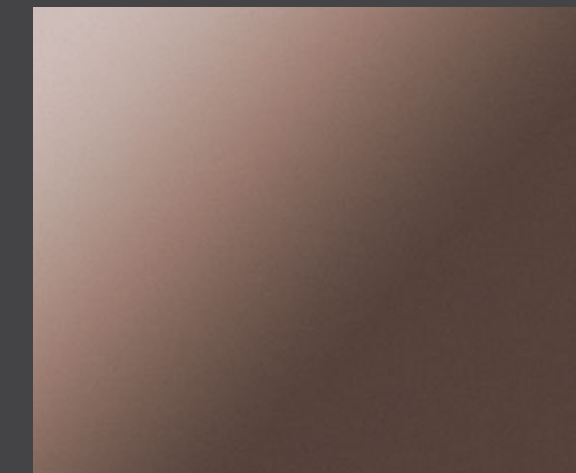

Rose Gold

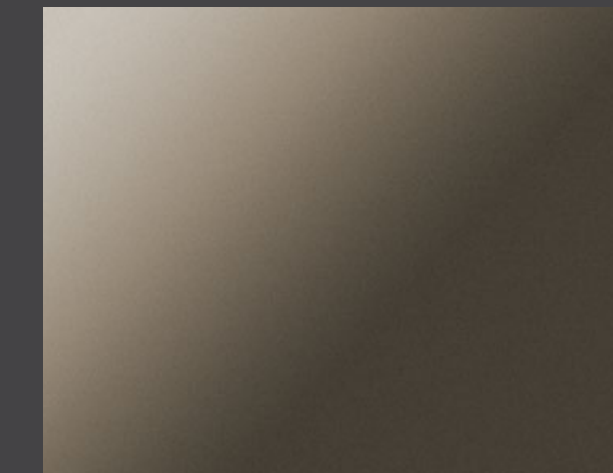

Iridium



Bianco  
White

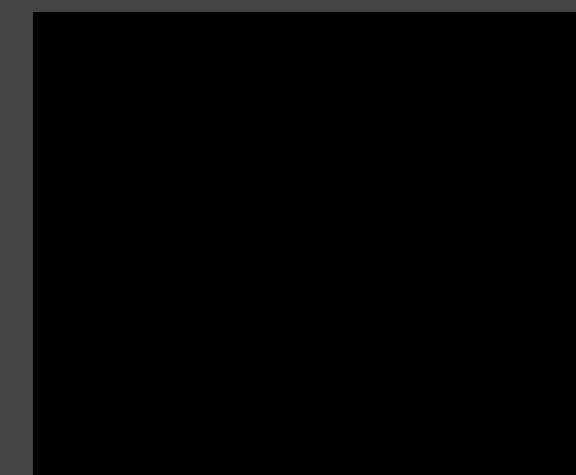

Nero  
Black



Brill

450  
EXECUTIVE



# disegni tecnici

technical drawings

## TAVOLI RIUNIONE / Meeting tables

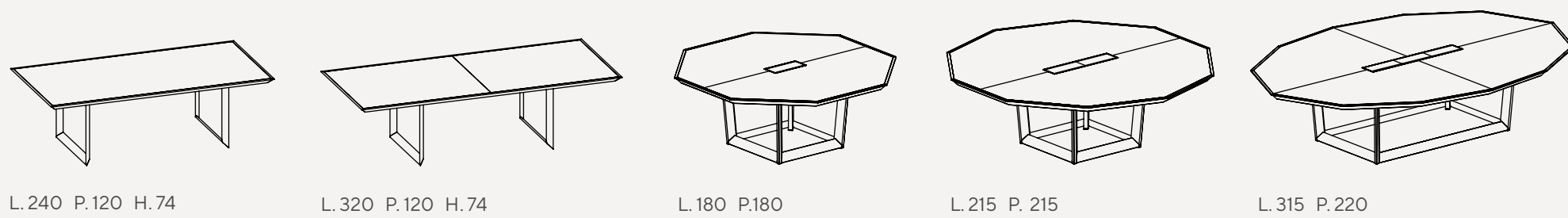

## TAVOLI RIUNIONE / Meeting tables

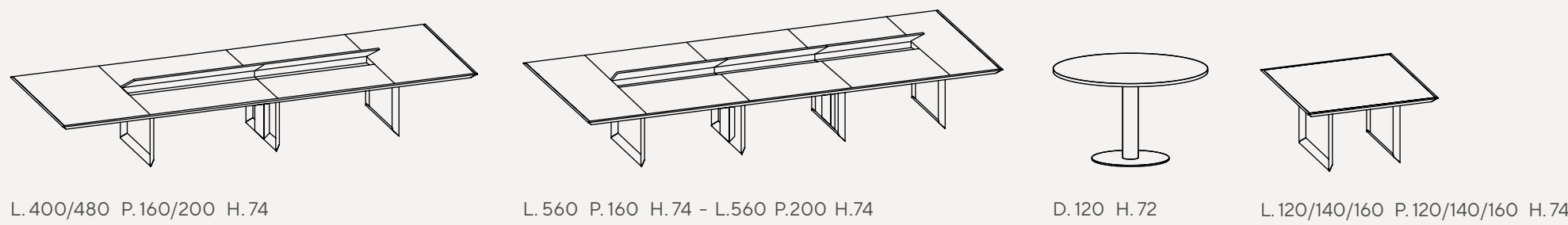
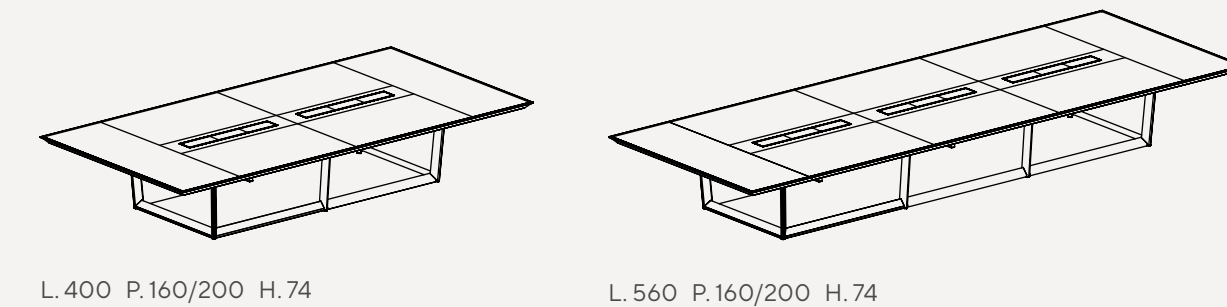
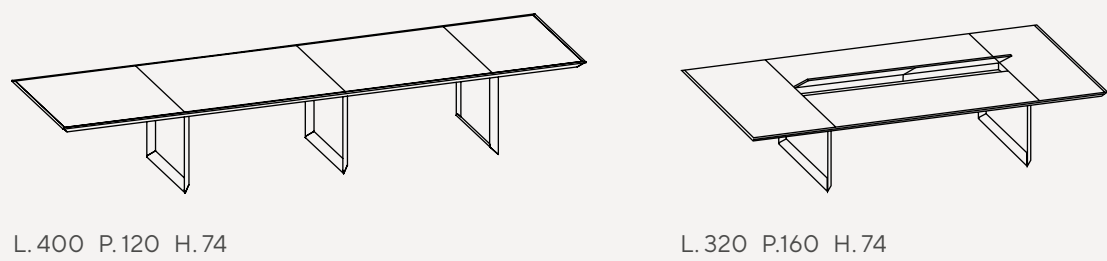
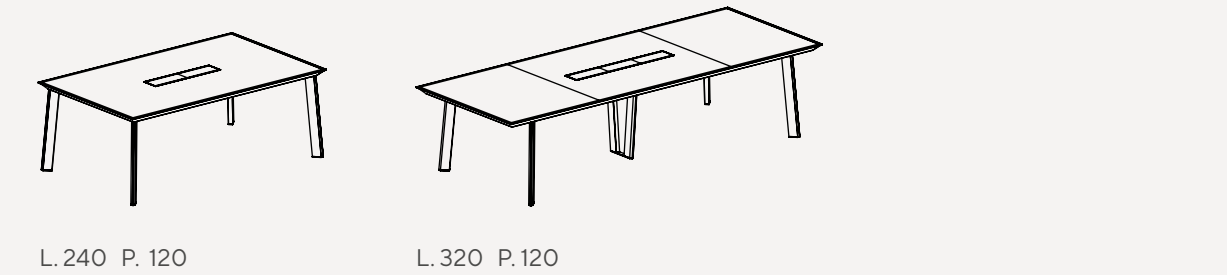

## TAVOLO CAFFÈ / Coffee table

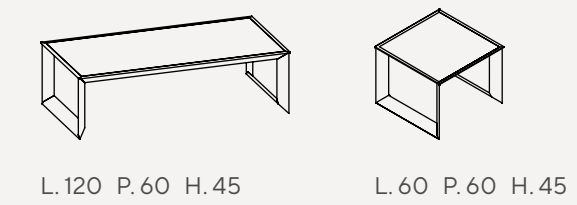



# disegni tecnici

technical drawings



## SCRIVANIE E COMPLEMENTI / Desks and accessories

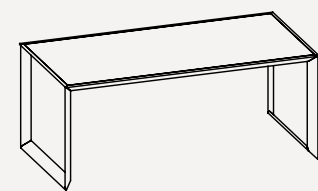

L.180/200/220 P.90 H.74



L.180/200 P.65 H.74

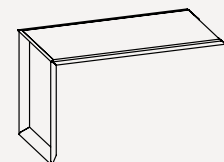

allungo / prolongation  
L.100/120/140 P.65 H.74



L.55 P.65,6 H.66

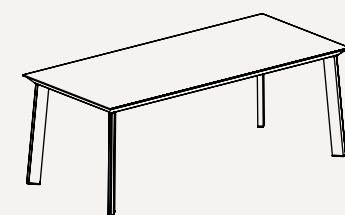

L.180/200/220 P.90 H.74

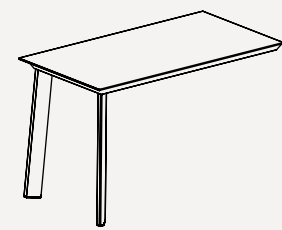

allungo / prolongation  
L.100/120/140 P.65 H.74

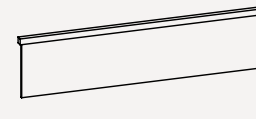

gonna / modesty panel  
L.180/200/220

## CONTENITORI DI SERVIZIO / Service storage units

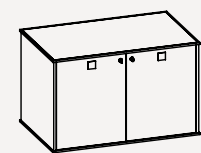

L.104,9 P.65,6 H.66

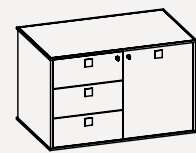

L.104,9 P.65,6 H.66

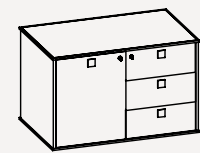

L.104,9 P.65,6 H.66

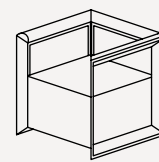

L.65 P.66 H.68,2

## POLTRONCINA / Easy chairs

## CONTENITORI / Storage units

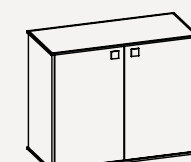

L.104,9 P.47,6 H.84,5

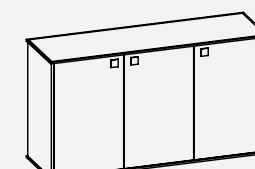

L.154,8 P.47,6 H.84,5

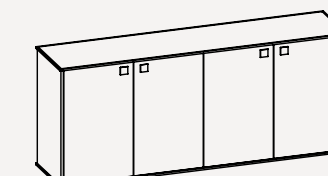

L.204,7 P.47,6 H.84,5

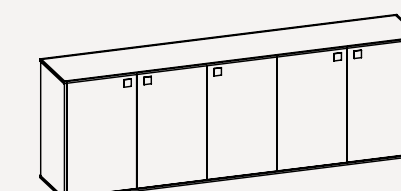

L.254,6 P.47,6 H.84,5

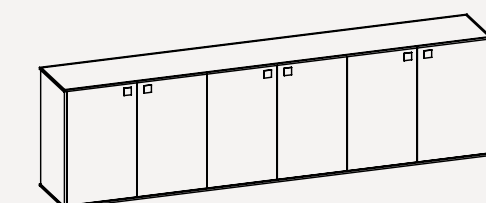

L.304,5 P.47,6 H.84,5

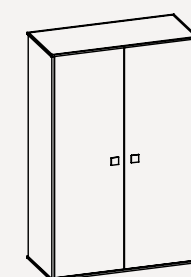

L.104,9 P.47,6 H.161,2

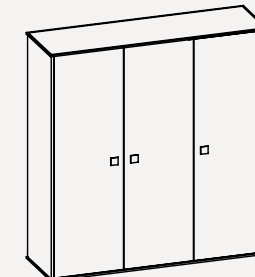

L.154,8 P.47,6 H.161,2

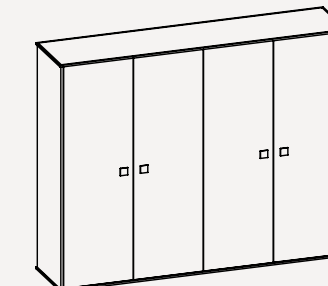

L.204,7 P.47,6 H.161,2

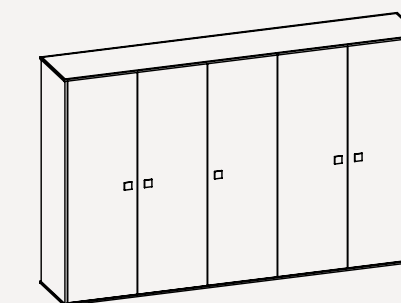

L.254,6 P.47,6 H.161,2

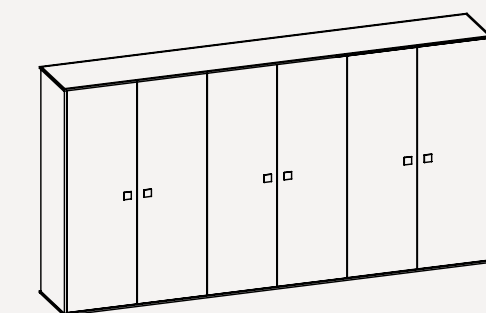

L.304,5 P.47,6 H.161,2

## LIBRERIA A PARETE / Partition bookcases

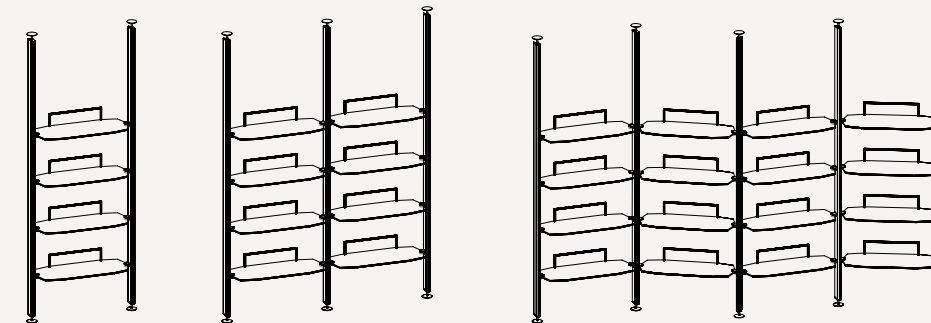

L.90 P.35 H.240/300

## LIBRERIA A MURO / Wall-mounted bookcases

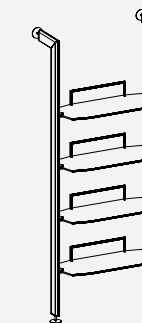

L.90 P.37 H.240



**Communication Lab**

Graphic Concept & Copying

Scenic design

Photorealistic 3D & Digital artbuyering

Finito di stampare a settembre 2021