

# mdf italia



© COPYRIGHT 2024 MDF ITALIA SRL SOCIETA' UNIPERSONALE

2017-2021

## 20.VENTI COLLECTION

Designed by 967ARCH

20.Venti is an office system with a linear, iconic, versatile design created by 967arch.

With a light structure, a contrast between full and empty, and quality materials and finishes, this is a contemporary interpretation of the desk, the archetypical workstation. Available in a wide range of sizes and colours, 20.Venti includes individual tables, double and quadruple workstations, a high workstation, and flexible combinations designed to adapt to spaces and the teams that use them.

Combined with various accessories, 20.Venti allows to create a welcoming, functional space for working agilely and productively. In 2020, 20.Venti was selected for the 26th ADI Compasso d'Oro.

Discover "[20.Venti Home](#)" and "[Home Light](#)", the new compact and versatile options of the iconic 20.Venti family.

## 20.VENTI

### FRAME AND TOP

Steel frame and legs, section 20x20 mm, painted with epoxy powder in the matt colours white and graphite grey. Structural wireway made of medium density fibreboard two-tone surfaced panels, thickness 2 cm, with the outside in matt colours white or graphite grey, and the inside always in medium grey. Tops are made of medium density fibreboard panels covered with Fenix NTM laminate in the matt colours white, light grey, medium grey and black.

Fenix NTM top in the colours pale grey and medium grey certified in compliance with standard UNI EN 13772 and UNI EN 13721.

### DIMENSIONS AND TYPES

- . Single desk H75, dim. 90x160, 90x180 and 90x200 cm.
- . Workstation two users H75, dim. 160x160 and 160x180 cm.
- . Workstation four users H75, dim. 160x320 or 160x360 cm.
- . Flex workstation H75, table depth 160 cm, in sizes that can be customised as required by using terminal or intermediate modules in the lengths 160 or 180 cm.
- . High workstation H110, dim. 100x160, 100x180 and 100x200 cm.

Adjustable aluminium foot with range of +/- 1 cm.

The single desk, the workstation two and four users and the workstation Flex have a structural wireway that can be accessed by sliding the top. It can be used for electrification and cables.

### ACCESSORIES

Open compartment, sound-absorption screen, PC stand with castors, wireway sleeve, stationary and document holder.

Available by project, partition with steel cables and two accessories for the structural wireway: the valet tray shelf and laptop or tablet bag (for min. 20 pieces).

## 20.VENTI LIGHT

### FRAME AND TOP

Matt white, light grey or black melamine tops. Steel frame and legs, section 20x20 mm, painted with epoxy powder in the matt colours white and graphite grey.

### DIMENSIONS AND TYPES

- . Single Desk H75, dim. 90x160 and 90x180 cm.
- . Light workstation two users H75, dim. 160x160 and 160x180 cm.
- . Light workstation four users H75, dim. 160x320 or 160x360 cm.
- . Light Flex workstation H75, table depth 160 cm, in sizes that can be customised as required by using terminal, or intermediate modules in the lengths 160 or 180 cm.

Adjustable aluminium foot with range of +/- 1 cm.

Equipped with cable opening on the top.

### ACCESSORIES

- . Finishing panels for the side frames of workstations.
- . Transparent plastic cable spring with aluminium painted base.
- . Under-top tray for cable collection.

## 20.Venti

### Single desk

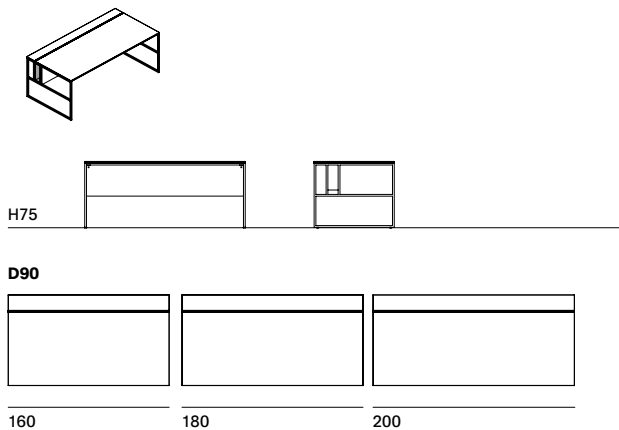

### Detail, dims in mm

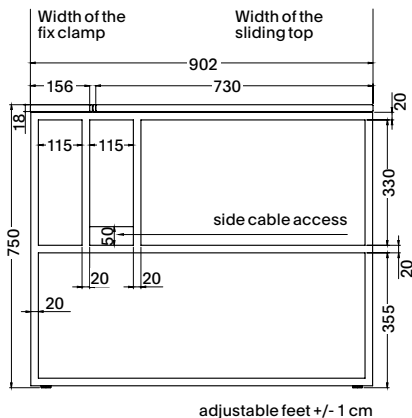

### Frame details

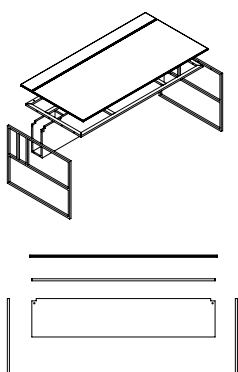

### Cabinet internal view

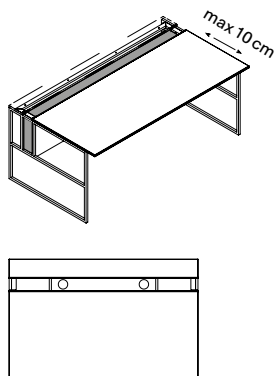

### Detail tabletop blocking system

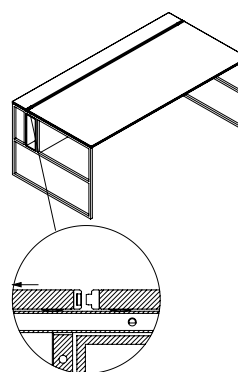

### Workstation 2 users

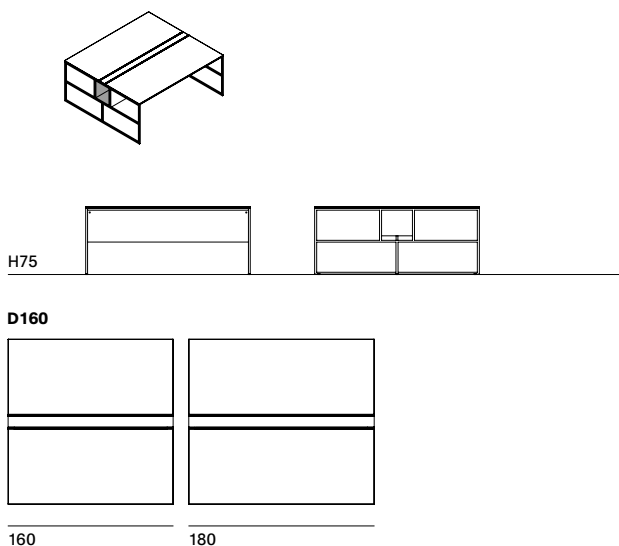

### Detail, dims in mm

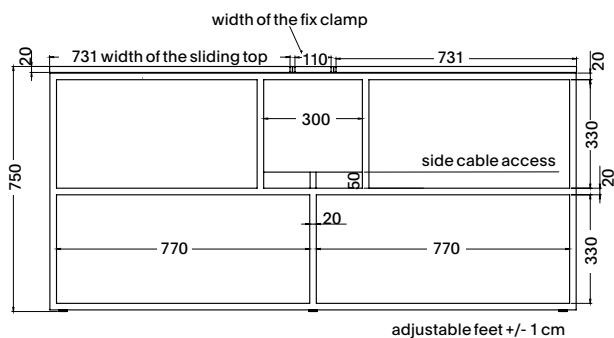

### Cabinet internal view

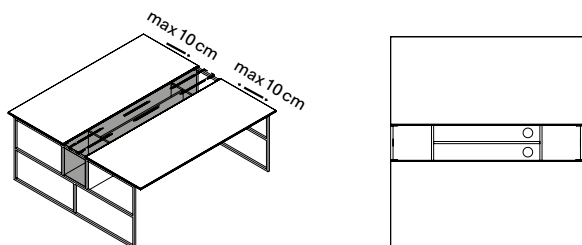

### Side cable access

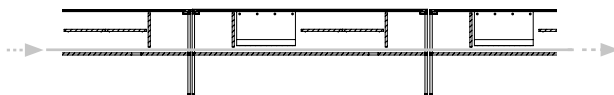

## 20.Venti

### Workstation 4 users

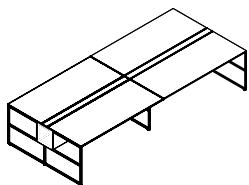

H75



### Workstation flex

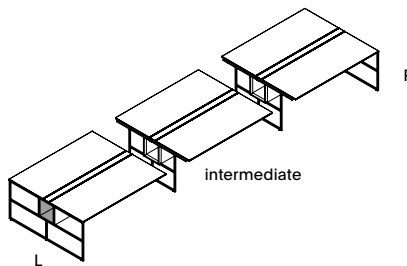

H75

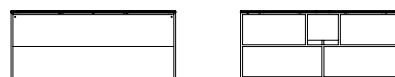

### D160

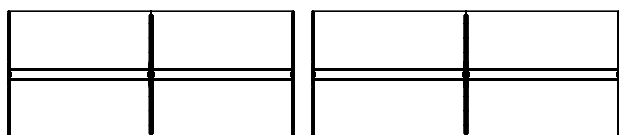

320

360

### D160

L terminal module

intermediate module

R terminal module

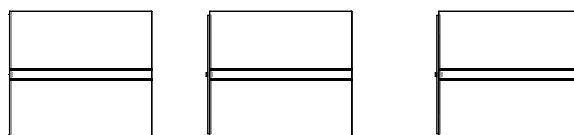

160

160

160

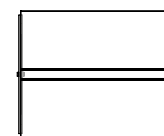
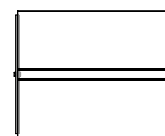
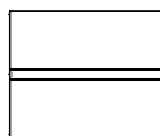

180

180

180

### High workstation

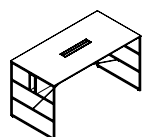

H110

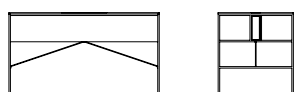

### D100

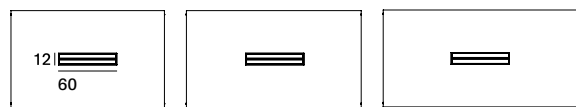

160

180

200

### Detail, dims in mm

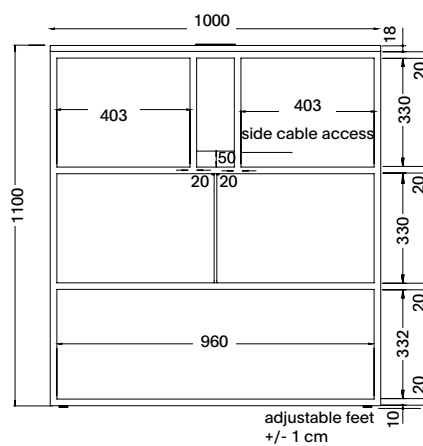

### Frame details

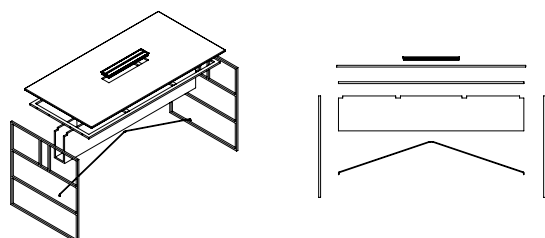

### Top-access detail

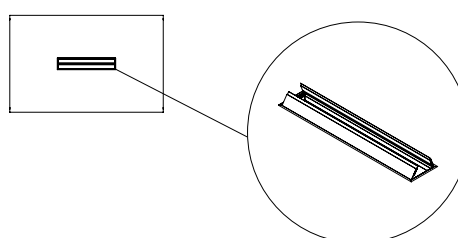

## 20.Venti

cable scheme and use of the internal cabinet without accessories

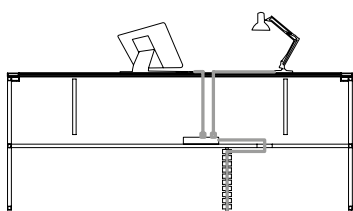

cable scheme and use of the accessories inside the internal cabinet

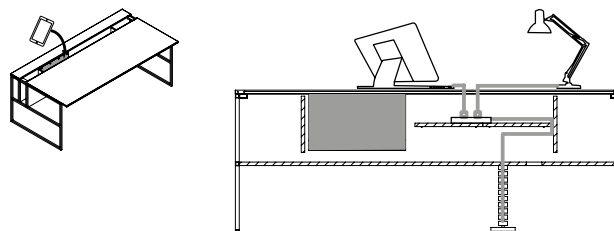

Sound-absorption screen

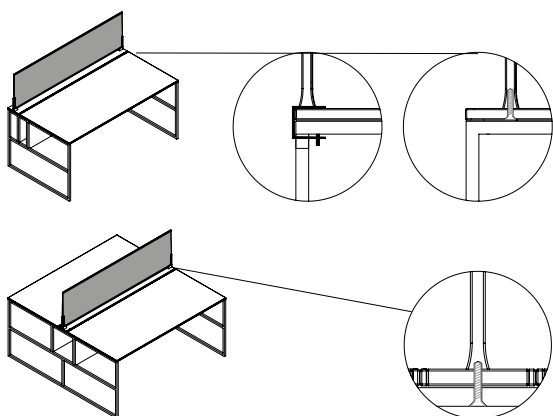

Open compartment

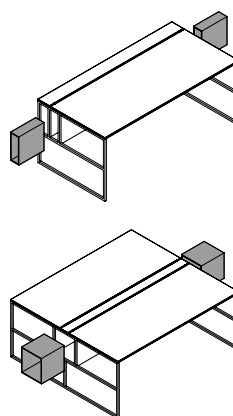

### Accessories



Sound-absorption screen  
And open compartment    PC stand with castors    Wireway sleeve

### Office Cabinets

three drawers + stationery drawer

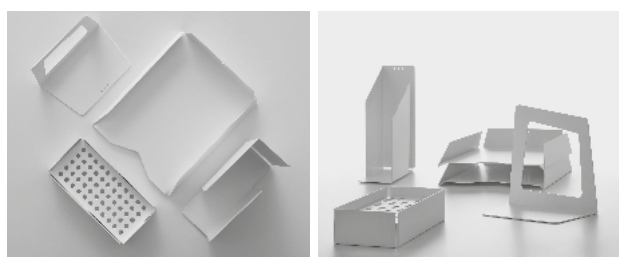
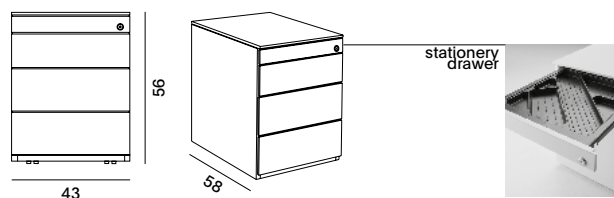

Stationary and document holder: pen holder, bookends, document holder.

drawer + filing unit + stationery drawer

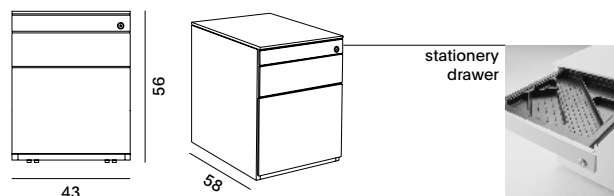

### Accessories by project



Partition with steel cables    Laptop or tablet bag    Valet tray shelf

### Office Cabinets Basic

three drawers

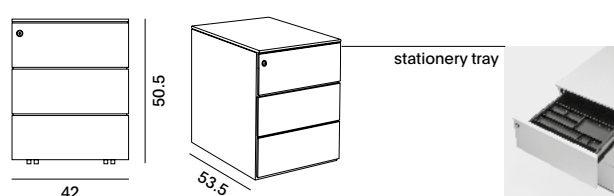

## 20.Venti Light

### Single desk

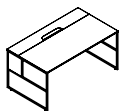

H75



P160

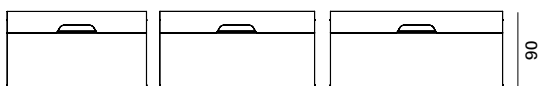

160

180

200

90

### Light Workstation two users

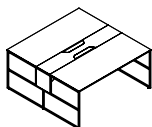

H75

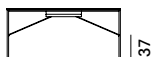

37

D160

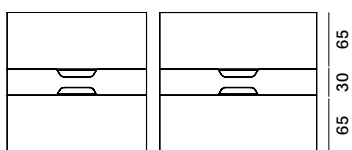

160

180

65  
30  
65

### Light workstation 4 users

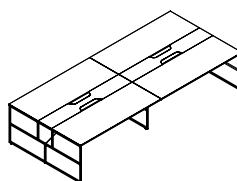

H75

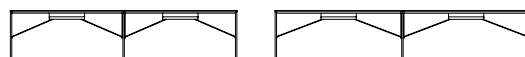

321

361

D160

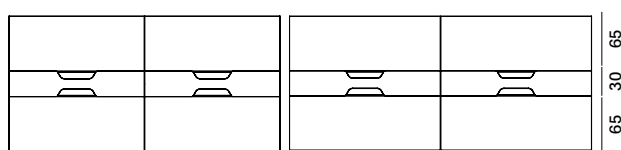

160

160

180

180

65  
30  
65

### Frame details

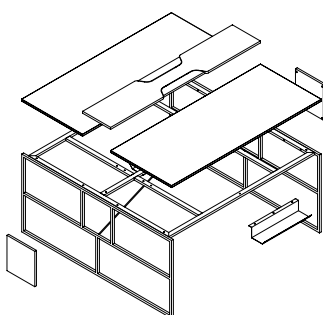

### Frame details, dims in mm

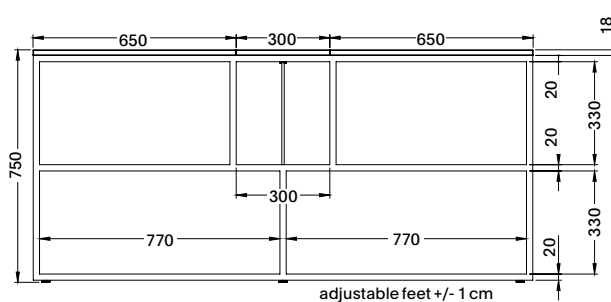

## 20.Venti Light

### Light flex workstation

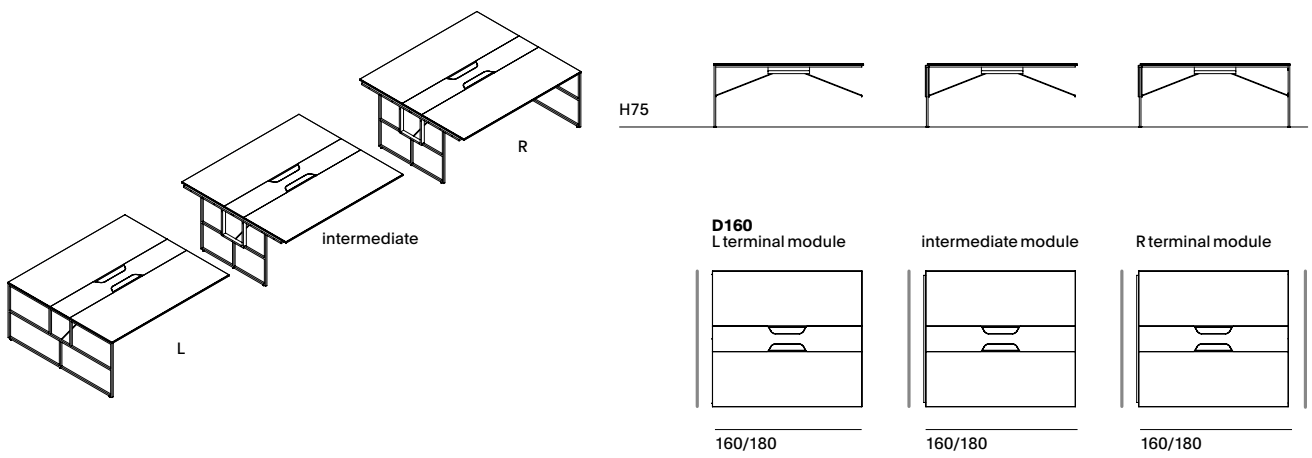

### Cable scheme

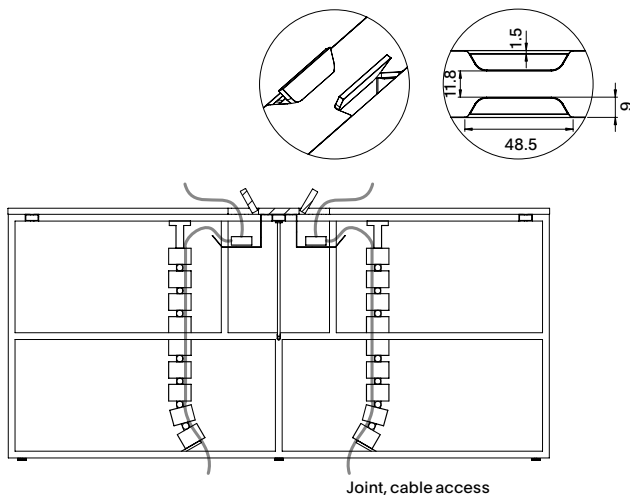

### Cable opening

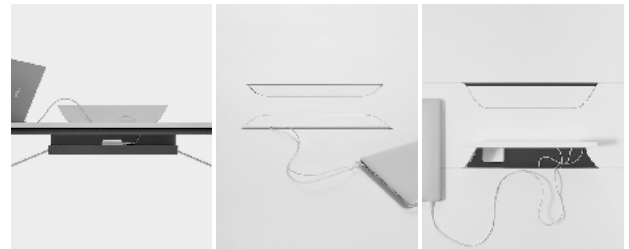

### Accessories

#### Sound-absorption screen

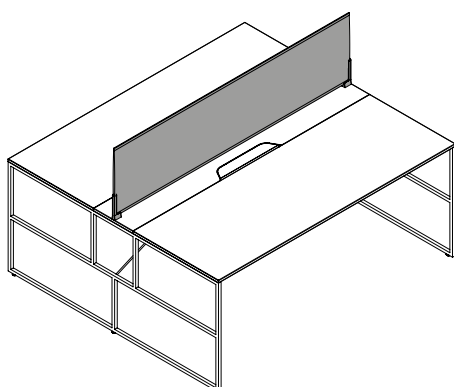

#### Finishing panels for the frame

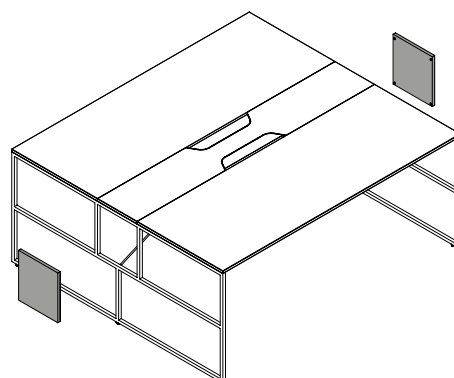

# Finishing

The number in the dot corresponds to the number of colour/material finish.

Here below, in the section FINISH OPTIONS, please note all the colours of the materials used for this product.

## 20.VENTI

---

### Top



Fenix

---

### Structure

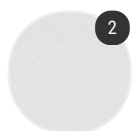

Matt painted

---

### Open compartment



Matt lacquered

---

## 20.VENTI LIGHT

---

### Top



Melamine

---

### Structure

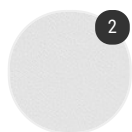

Matt painted



## 20.VENTI LIGHT PANEL FINISHES

---

### Structure



Melamine

# Finish options

## TOP

---

### Fenix



Fenix matt  
white X020

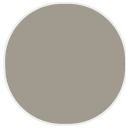

Fenix matt  
light grey

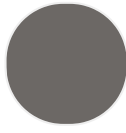

Fenix matt  
medium grey  
X021



Fenix matt  
black X022

### Melamine



Matt  
melamine  
white

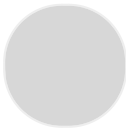

Matt  
melamine  
light gray

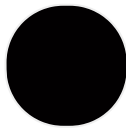

Matt  
melamine  
black

## STRUCTURE

---

### Matt painted



Matt painted  
white X053



Matt painted  
graphite grey  
X054

### Melamine



Matt  
melamine  
white

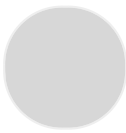

Matt  
melamine  
light gray

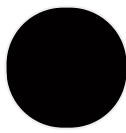

Matt  
melamine  
black

## OPEN COMPARTMENT

---

Matt lacquered



Matt painted  
white X042



Matt  
lacquered  
dune X162



Matt  
lacquered  
burgundy  
X163



Matt  
lacquered  
English green  
X164



Matt  
lacquered  
navy blue  
X165